



## AXIAL BIFURCATOR FANS

Models: SSB - Single Stage  
TSB - Two Stage

### **FANSIZER® Product Selection Software**

FanSizer software allows you to select the best centrifugal or axial unit for your application. Input CFM and static pressure, and FanSizer will make the optimum selection. It allows you to complete job schedules which you can store, modify and print in seconds. Features include: on-line help, on-screen product drawings and dimensions, and complete text specifications. In addition, you can convert job schedules to ASCII code for use with other programs like word processing.

### **FANCAD® Library of CAD Drawings**

FanCad is a library of drawings for use with computer-aided design (CAD) systems. FanCad's pre-drawn details can save hours of drafting time. Included are all popular PennBarry fans and related items.

### **Visit Our Web Site**

Point your internet web browser to [www.PennBarry.com](http://www.PennBarry.com) for up-to-the-minute information including:

- On-line catalog
- List of nearest PennBarry representatives
- What's New
- HVAC "Hot Links"

FanSizer and FanCad are registered trademarks.

## Table of Contents

Introduction . . . . .	1
General Information . . . . .	2
Features and Benefits . . . . .	3
Options and Accessories . . . . .	4
Selection Criteria . . . . .	5
SSB - Fan Data . . . . .	6
TSB - Fan Data . . . . .	11
Sample Specifications . . . . .	15
Limited Warranty . . . . .	16

# General Information

## SSB/TSB - Bifurcator Fan



**Single Stage  
Bifurcator**



**Two Stage  
Bifurcator**



Bifurcator blowers are a quality product engineered and built to last. Standard construction offers minimum maintenance direct drive design with motor out of air stream. Bifurcator blowers are built of heavy gauge steel throughout, top name brand electric motors are used, continuous welding of seams and use of angle iron inlet and outlet flanges is standard. Special attention is given to the in-line air flow characteristics to provide minimum internal restriction. The results of these efforts are products which deliver superior performance, with minimum downtime for maintenance and exceptional full-life value.

- Wheel diameters from 12" through 60"
- CFM capacity ranges from 750 to 80,000
- Application temperatures of -20°F to 1000°F
- Useful for applications in many industries, such as food processing, glass, breweries, chemical plants, pulp and paper, meat packing, hot metal, rubber and dairy
- Heavy gauge steel and continuous welding

### The Bifurcated Principle

Dictionaries define the term "bifurcate" as follows: "To divide into two branches." That is essentially what the Bifurcator blower provides. The two branches of the air stream pass on each side of the isolated motor chamber as shown in the drawing to the right. The motor chamber is isolated from elevated temperatures by liners and insulation packages. Motors are provided with shaft extensions and heat slingers to protect bearings and windings. The special high strength, high performance propellers are designed to minimize mechanical failures. The blades are riveted to the hub to eliminate stress cracking of welded joints.

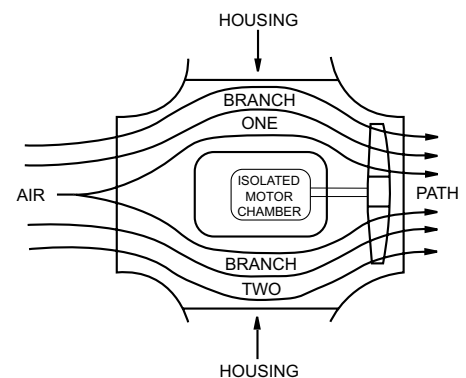

# Features and Benefits

## Bifurcator Fan - SSB/TSB

**Single Stage and Two Stage Bifurcators** are inline axial blowers designed especially to move large volumes of gases.

Because of the bifurcated housing, the blowers can exhaust very hot air, corrosive gases and flammable fumes (with optional spark resistant construction). The motor is isolated from destructive heat and fumes in a separate chamber, so that it can remain cool and clean even after extended operation. The only moving part exposed to heat and fumes is the specially designed propeller.

The specially designed propeller is the key to the tremendous air moving capabilities of

the bifurcated fan. The design divides the air stream into two branches with minimal losses.

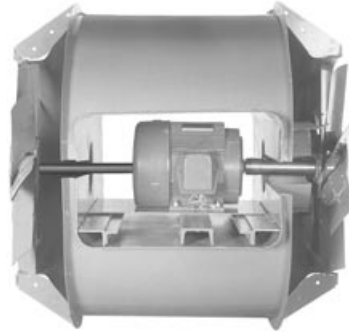

Single stage and two stage bifurcators are available in a wide range of sizes and air movement capacities. Direct drive models are available with propeller diameters from 12" to 60" and air capacities of 750 to 80,000 CFM. Belt drive single stage bifurcators are available on special order. Our engineering department will work with any customer to satisfy needs for belt drive bifurcators.

### Simple Installation and Maintenance

Single stage and two stage Bifurcator fans can be mounted directly into ductwork. They can be mounted in any position with no loss of performance. High efficiency allows the fan to be mounted on a roof curb and topped with weather protection, to perform as a roof exhauster. The Bifurcator upblast stack head is recommended for use with the Bifurcator fans when weather protection is needed.

The standard single stage and two stage Bifurcators feature removable cone half sections which make inspection and/or removal of the motor propeller very simple. The fan can be serviced in this manner without being removed from connecting ductwork. A Slide-Out® feature is available as an option. This feature supports the mounted motor and propeller as it is slid out of the housing and allows thorough visual inspection and/or cleaning without dismounting the motor or propeller.



### Special Materials & Coatings

Bifurcator construction materials and coatings are offered in a wide variety. The offering is broad enough that most special situations can be accommodated. The chart below shows the available materials and coatings. Contact the factory for additional coatings not shown.

AVAILABLE CONSTRUCTION	AVAILABLE COATINGS
450°F	
750°F	Air-Dry Enamel
900°F	Heresite
1000°F	High Temperature
Aluminum	Epoxy
316SS	Hot Dip Galvanize
Spark Resistant	

# Options and Accessories

## SSB/TSB - Bifurcator Fans

- |                        |                                  |                                      |
|------------------------|----------------------------------|--------------------------------------|
| 1. 250°F Construction  | 10. Mounting Rails               | 19. Inlet/Outlet Bell                |
| 2. 450°F Construction  | 11. Guy Wire Anchor              | 20. Shaft Seal                       |
| 3. 750°F Construction  | 12. Stack Support Bracing        | 21. Curb Cap                         |
| 4. 1000°F Construction | 13. NEMA I Disconnect            | 22. Upblast Discharge Head           |
| 5. Hot Dip Galvanize   | 14. NEMA III Disconnect          | 23. Manual Shutter (Curb Mounted)    |
| 6. Spark Resistant     | 15. Heat Slinger                 | 24. Motorized Shutter (Curb Mounted) |
| 7. All Aluminum        | 16. Glass Wool Lining            | 25. Bolt on Volume Control Damper    |
| 8. Companion Flange    | 17. Aluminum Motor Chamber Liner | 26. Motor Chamber Louvers (2)        |
| 9. Mounting Feet       | 18. Slyde-Out® Motor Base        | 27. Motor Chamber Bird Screen (2)    |

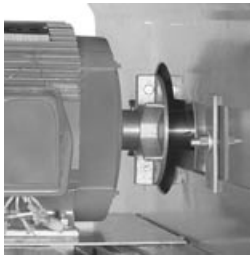

Heat Slinger

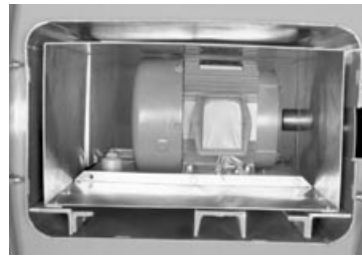

Aluminum Motor Chamber Liner



Slide-Out®



Curb Cap



Companion Flange

### Optional Construction - Power Roof Ventilator (PRV)

SIZE	A	B	C	D	E	UNIT WEIGHT*
012	22.50	24.25	18.00	16.00	8.00	195
016	29.50	28.25	22.00	16.00	8.00	265
018	28.88	30.25	24.00	20.00	8.00	330
021	32.00	33.25	27.00	20.00	8.00	365
o 024	36.38	36.25	30.00	22.00	8.00	529
024	42.75	36.25	30.00	22.00	8.00	580
027	41.00	39.25	33.00	22.00	8.00	730
030	42.75	42.25	36.00	24.00	8.00	865
036	50.00	48.25	42.00	28.00	8.00	1025
+ 036	56.00	48.25	42.00	28.00	8.00	1100
042	52.00	54.25	48.00	32.00	8.00	1270
048	60.00	60.25	54.00	36.00	8.00	1569
060	77.00	72.25	66.00	44.00	8.00	3036

o Two Stage Only

+ 324T Frame

\* Less Motor

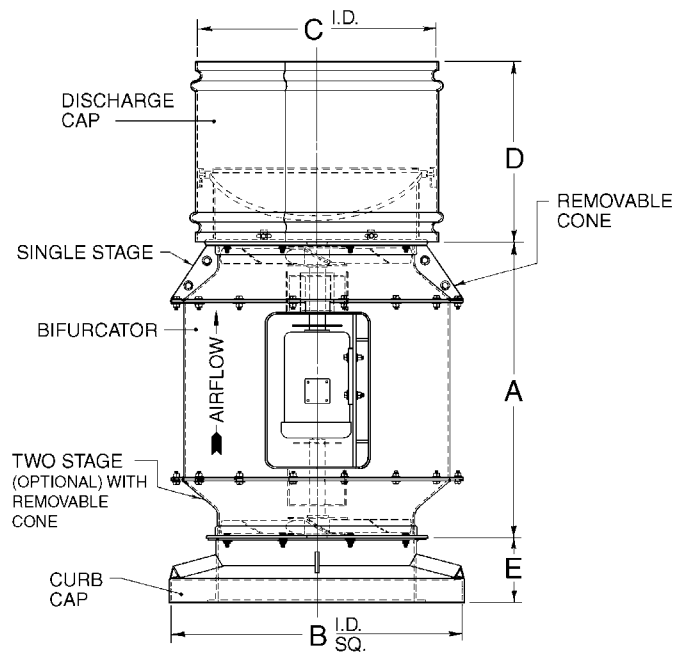

# Selection Criteria

## Bifurcator Fan - SSB/TSB

FAN TEMP. CLASS		DIRECT DRIVE BIFURCATOR SINGLE & TWO STAGE CONSTRUCTION
I	-20°/105°F -30°/40°C	Total fan of hot rolled steel construction; Class "B" motor insulation
II	106°/175°F 41°/80°C	Total fan of hot rolled steel construction; Class "B" motor insulation
III	176°/250°F 81°/120°C	Total fan of hot rolled steel construction; Class "B" motor insulation; Temperature correct for static pressure (SP) and horsepower (HP)
IV	251°/450°F 121°/230°C	Total fan of hot rolled steel construction; Class "B" motor insulation; Temperature correct for static pressure (SP) and horsepower (HP); Requires blanket insulation and heat slinger.
V	451°/750°F	Total fan except propeller of hot rolled steel construction; 316SS Propeller; Class "F" motor insulation; Temperature correct for static pressure (SP) and horsepower (HP); Requires heat slinger; Aluminium motor chamber liner; High temperature paint and shaft seal.
VI	751°/1000°F 401°/538°C	Total fan except propeller of 304SS construction; 316SS Propeller; Class "H" motor insulation; Temperature correct for static pressure (SP) and horsepower (HP); Requires heat slinger; Aluminium motor chamber liner; High temperature paint and shaft seal.

### Elevated Temperature Construction Directory

Bifurcator fans are designed to safely operate over a wide temperature range (-20°F to 1000°F). The chart at the left displays the temperature ranges available for the single and two stage bifurcator. The recommended construction characteristics for each temperature step is defined in this chart.

### Bifurcator Temperature Correction

#### A. System Requirement at Operating Conditions

- Given Info: \_\_\_\_\_ CFM, \_\_\_\_\_ "SP, \_\_\_\_\_ °F, \_\_\_\_\_ Alt.  
A. For above; CFM, "SP, °F and Alt. Are All at Design Operating Conditions.
- Consult Chart Below for Correction Factor (CF) = \_\_\_\_\_

B. Correct "SP by doing  $\frac{\text{Given "SP}}{\text{CF}} = \frac{?}{?} = \text{_____ "SP}$

C. Select Fan for Given CFM \_\_\_\_\_ and Corrected "SP \_\_\_\_\_

- D. Selection: \_\_\_\_\_ : \_\_\_\_\_ HP, \_\_\_\_\_ RPM
- Selected Fan Data: \_\_\_\_\_ CFM, \_\_\_\_\_ "SP, \_\_\_\_\_ HP
  - Hot Run HP = \_\_\_\_\_ Selected HP x \_\_\_\_\_ CF = \_\_\_\_\_ HP
  - Cold Start HP (70°F) = HP of Above Line "D" = \_\_\_\_\_ HP

#### E. Example:

- \_\_\_\_\_ **15,000** CFM,  $\frac{1}{2}$ " "SP, **500** °F, **0** Alt.
- Correction Factor (CF) = **0.552**

B.  $\frac{\text{Given "SP}}{\text{CF}} = \frac{0.5}{0.552} = \text{0.91 "SP}$

C. Select Fan for Given CFM **15,000** and Corrected "SP **0.91**

- D. Selection: **036 - Pitch 23** : **10** HP, **1140** RPM
- Selected Fan Data: **15,000** CFM, **0.91** "SP, **10** HP
  - Hot Run HP = **10** Selected HP x **0.552** CF = **5.52** HP
  - Cold Start HP\* (70°F) = HP of Above Line "D" = **10** HP  
\* Without Dampers or Restriction to Reduce Cold Start Air Flow

### Temperature and Altitude Correction Factors

°F	ELEVATION ABOVE SEA LEVEL, FT.																	
	0	500	1000	1500	2000	2500	3000	3500	4000	4500	5000	6000	7000	8000	9000	10000	15000	20000
70	1.000	.981	.964	.947	.930	.912	.896	.880	.864	.848	.832	.816	.772	.743	.714	.688	.564	.460
100	.946	.929	.912	.896	.880	.864	.848	.833	.818	.802	.787	.772	.758	.730	.703	.676	.534	.435
150	.869	.853	.838	.823	.808	.793	.779	.765	.751	.737	.723	.696	.671	.646	.620	.598	.490	.400
200	.803	.788	.774	.760	.747	.733	.720	.707	.694	.681	.668	.643	.620	.596	.573	.552	.453	.369
250	.747	.733	.720	.707	.694	.681	.669	.657	.645	.633	.622	.598	.576	.555	.533	.514	.421	.344
300	.697	.684	.672	.660	.648	.636	.624	.613	.602	.591	.580	.558	.538	.518	.498	.480	.393	.321
350	.654	.642	.631	.619	.608	.597	.586	.575	.565	.554	.544	.524	.505	.486	.467	.450	.369	.301
400	.616	.605	.594	.583	.573	.562	.552	.542	.532	.522	.513	.493	.476	.458	.440	.424	.347	.283
450	.582	.571	.561	.551	.542	.532	.522	.512	.503	.493	.484	.466	.449	.433	.416	.401	.328	.268
500	.552	.542	.532	.522	.513	.504	.495	.486	.477	.468	.459	.442	.426	.410	.394	.380	.311	.254
550	.525	.515	.506	.497	.488	.479	.470	.462	.454	.445	.437	.421	.405	.390	.375	.361	.296	.242
600	.500	.491	.482	.473	.465	.456	.448	.440	.432	.424	.416	.400	.386	.372	.352	.344	.282	.230
650	.477	.468	.460	.452	.444	.435	.427	.419	.412	.404	.397	.382	.368	.354	.341	.328	.269	.219
700	.457	.449	.441	.433	.425	.417	.410	.402	.395	.387	.380	.366	.353	.340	.326	.315	.258	.210
800	.420	.412	.405	.398	.391	.384	.377	.370	.363	.356	.350	.337	.325	.312	.300	.289	.237	.193
900	.389	.382	.375	.368	.362	.355	.349	.342	.336	.330	.324	.312	.300	.289	.278	.268	.219	.179
1000	.363	.356	.349	.342	.337	.331	.325	.319	.314	.308	.302	.291	.280	.270	.259	.250	.205	.167

# Single Stage Fan Data

SSB - Bifurcator

## 012

Wheel Diameter = 12 in.	Maximum RPM = 1750
Tip Speed, FPM = 6.28 x RPM	Unit Weight = 93 lbs.
Outlet Flange Screws: 4 Required, Hole Diameter = .38 x .50	

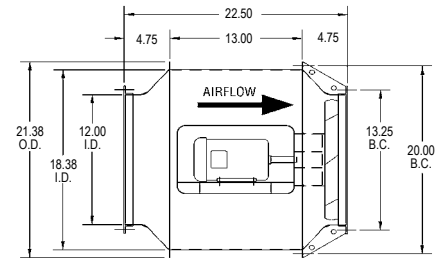

FAN RPM	MTR HP	PITCH	0" SP	1/8" SP	1/4" SP	3/8" SP	1/2" SP	5/8" SP	3/4" SP
			CFM	CFM	CFM	CFM	CFM	CFM	CFM
1750	1/4	27	1260	1105	950	750			

## 016

Wheel Diameter = 16 in.	Maximum RPM = 1750
Tip Speed, FPM = 4.19 x RPM	Unit Weight = 145 lbs.
Outlet Flange Screws: 8 Required, Hole Diameter = .38	

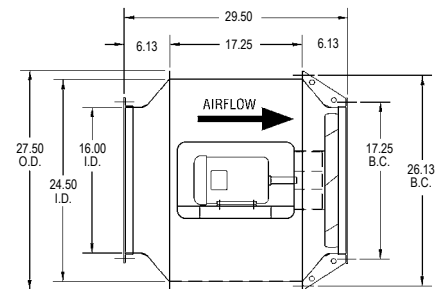

FAN RPM	MTR HP	PITCH	0" SP	1/8" SP	1/4" SP	3/8" SP	1/2" SP	5/8" SP	3/4" SP
			CFM	CFM	CFM	CFM	CFM	CFM	CFM
1160	1/3	27	1765	1600	1350				
1750	1/2	27	2680	2583	2475	2360			

## 018

Wheel Diameter = 18 in.	Maximum RPM = 1750
Tip Speed, FPM = 4.71 x RPM	Unit Weight = 205 lbs.
Outlet Flange Screws: 8 Required, Hole Diameter = .44	

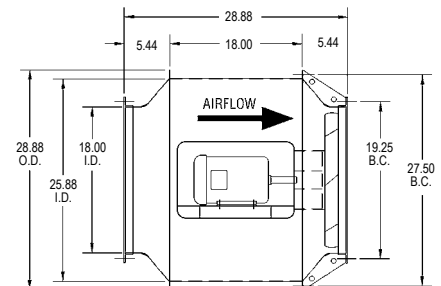

FAN RPM	MTR HP	PITCH	0" SP	1/8" SP	1/4" SP	3/8" SP	1/2" SP	5/8" SP	3/4" SP
			CFM	CFM	CFM	CFM	CFM	CFM	CFM
1160	1/3	18	2365	2090	1630				
	1/3	23	2530	2240	1740				
	1/3	28	2700	2400	1840				
	1/2	33	2835	2540					
	1/2	37	2990	2670					
1750	1	18	3560	3400	3200	2980	2680	2280	
	1	23	3800	3620	3400	3040	2840	2400	
	1 1/2	28	4040	3840	3620	3340	3000		
	1 1/2	33	4280	4100	3880	3620	3240		
	2	37	4500	4400	4160	3860	3440		

- Notes:**
- 1) Performance shown is for Installation Type D: ducted inlet, ducted outlet.
  - 2) Performance ratings do not include the effects of appurtenances in the airstream.
  - 3) Power rating (BHP) does not include drive losses.
  - 4) Approximate fan weights are less motor and accessories.
  - 5) Size 012 and 016 fans will always be furnished with a 4-blade prop. Larger sizes will be furnished with an 8-blade prop.

# Single Stage Fan Data

Bifurcator - SSB

## 021

Wheel Diameter = 21 in.	Maximum RPM = 1750
Tip Speed, FPM = 5.50 x RPM	Unit Weight = 225 lbs.
Outlet Flange Screws: 8 Required, Hole Diameter = .44	

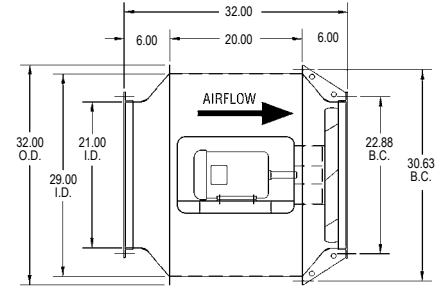

FAN RPM	MTR HP	PITCH	0" SP	1/8" SP	1/4" SP	3/8" SP	1/2" SP	5/8" SP	3/4" SP
			CFM	CFM	CFM	CFM	CFM	CFM	CFM
1160	3/4	18	3750	3425	3020	2350			
	3/4	23	4025	3675	3220				
	3/4	28	4250	3900	3440				
	1	33	4500	4150	3650				
	1	37	4750	4400	3890				
1750	2	18	5680	5500	5260	5020	4760	4420	4000
	2	23	6060	5840	5620	5360	5060	4700	4300
	3	28	6460	6240	6020	5740	5420	5040	4580
	3	33	6800	6600	6360	6100	5760	5320	4760
	5	37	7160	6860	6720	6440	6080	5600	

## 024

Wheel Diameter = 24 in.	Maximum RPM = 1750
Tip Speed, FPM = 6.28 x RPM	Unit Weight = 359 lbs.
Outlet Flange Screws: 8 Required, Hole Diameter = .44	

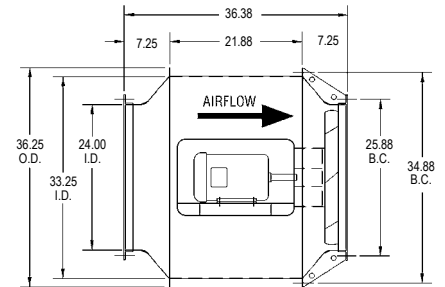

FAN RPM	MTR HP	PITCH	0" SP	1/8" SP	1/4" SP	3/8" SP	1/2" SP	5/8" SP	3/4" SP	7/8" SP	1" SP
			CFM	CFM	CFM	CFM	CFM	CFM	CFM	CFM	CFM
1160	1 1/2	18	6000	5640	5200	4600					
	1 1/2	23	6460	6040	5540	4980					
	1 1/2	28	6900	6460	5980	5380					
	1 1/2	33	7320	6880	6460	5800					
	2	37	7760	7300	6820	6260					
1750	5	18	9000	8700	8500	8200	7900	7600	7250	6800	6200
	5	23	9600	9400	9175	8850	8500	8200	7800	7350	6700
	5	28	10300	10100	9750	9500	9200	8900	8500	8000	7300
	5	33	10950	10700	10375	10100	9800	9500	9100	8600	8000
	7 1/2	37	11600	11300	11000	10700	10400	10050	9650	9150	8500

- Notes:**
- 1) Performance shown is for Installation Type D: ducted inlet, ducted outlet.
  - 2) Performance ratings do not include the effects of appurtenances in the airstream.
  - 3) Power rating (BHP) does not include drive losses.
  - 4) Approximate fan weights are less motor and accessories.



# Single Stage Fan Data

SSB - Bifurcator

## 027

Wheel Diameter = 27 in.	Maximum RPM = 1750
Tip Speed, FPM = 7.07 x RPM	Unit Weight = 555 lbs.
Outlet Flange Screws: 8 Required, Hole Diameter = .44	

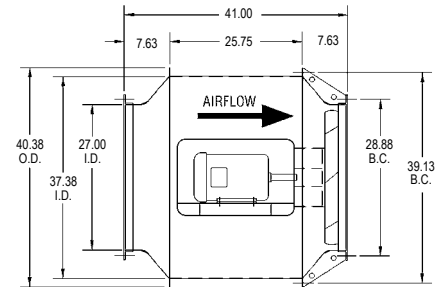

FAN RPM	MTR HP	PITCH	0" SP	1/8" SP	1/4" SP	3/8" SP	1/2" SP	5/8" SP	3/4" SP	7/8" SP	1" SP
			CFM	CFM	CFM	CFM	CFM	CFM	CFM	CFM	CFM
1160	2	18	8500	8075	7600	7100	6300	5000			
	2	23	9000	8600	8150	7650	6900	5600			
	3	28	9700	9300	8800	8300	7400				
	3	33	10300	9900	9400	8900	8000				
	3	37	11000	10500	10000	9500	8800				
1750	7 1/2	18	12800	12500	12200	12000	11600	11250	11000	10600	10200
	7 1/2	23	13700	13400	13150	12850	12450	12100	11750	11400	10950
	7 1/2	28	14600	14300	14000	13700	13400	13050	12700	12800	11800
	10	33	15600	15300	15000	14800	14300	14000	13700	13300	12800
	10	37	16500	16200	15800	15500	15150	14800	14500	14100	13700

FAN RPM	MTR HP	PITCH	1 1/4" SP	1 1/2" SP
			CFM	CFM
1750	7 1/2	18	9000	
	7 1/2	23	9800	
	7 1/2	28	10600	
	10	33	11600	
	10	37	12600	

## 030

Wheel Diameter = 30 in.	Maximum RPM = 1160
Tip Speed, FPM = 7.85 x RPM	Unit Weight = 635 lbs.
Outlet Flange Screws: 16 Required, Hole Diameter = .44	

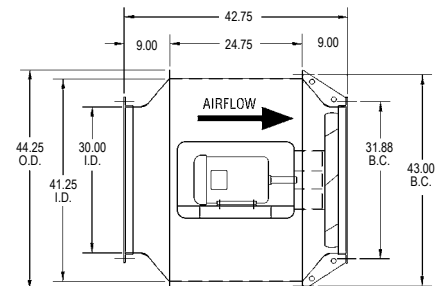

FAN RPM	MTR HP	PITCH	0" SP	1/8" SP	1/4" SP	3/8" SP	1/2" SP	5/8" SP	3/4" SP
			CFM	CFM	CFM	CFM	CFM	CFM	CFM
870	1 1/2	18	8800	8100	7300	6300			
	1 1/2	23	9400	8700	7800	6700			
	2	28	10000	9350	8500	7100			
	2	33	10700	10050	9200				
	3	37	11700	10900	9900				
1160	3	18	11800	11200	10700	10100	9400	8700	
	5	23	12400	12000	11500	10900	10000	9200	
	5	28	13400	12950	12450	11800	10700	9800	
	5	33	14300	13850	13200	12700	11800	10500	
	7 1/2	37	15300	14850	14300	13600	12700		

- Notes:**
- 1) Performance shown is for Installation Type D: ducted inlet, ducted outlet.
  - 2) Performance ratings do not include the effects of appurtenances in the airstream.
  - 3) Power rating (BHP) does not include drive losses.
  - 4) Approximate fan weights are less motor and accessories.

# Single Stage Fan Data

Bifurcator - SSB

## 036

Wheel Diameter = 36 in.	Maximum RPM = 1160
Tip Speed, FPM = 9.42 x RPM	Unit Weight = 716 lbs.
Outlet Flange Screws: 16 Required, Hole Diameter = .44	

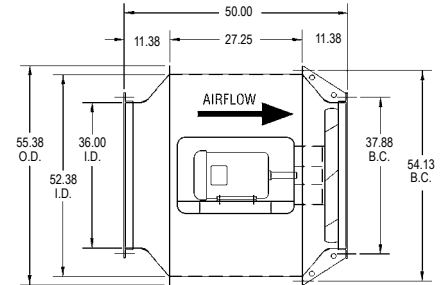

FAN RPM	MTR HP	PITCH	0" SP	1/8" SP	1/4" SP	3/8" SP	1/2" SP	5/8" SP	3/4" SP	7/8" SP	1" SP
			CFM	CFM	CFM	CFM	CFM	CFM	CFM	CFM	CFM
870	5	18	15000	14400	13600	12500	11400	9400			
	5	23	16400	15500	14700	13500	12200				
	5	28	17400	16500	15600	14500	12800				
	7 1/2	33	18500	17800	16800	15800	13600				
	7 1/2	37	19800	19000	18000	16700	14400				
1160	7 1/2	18	20200	19600	19000	18600	17800	17000	16200	15400	14000
	10	23	21800	21200	20600	20000	19300	18600	17500	16400	15000
	15	28	23200	22800	22200	21600	21000	20100	18800	17400	
	15	33	24800	24300	23700	22800	22200	21500	20000	18400	
	15	37	26500	25900	25300	24400	23600	22800	21600		

## 042

Wheel Diameter = 42 in.	Maximum RPM = 870
Tip Speed, FPM = 11.00 x RPM	Unit Weight = 900 lbs.
Outlet Flange Screws: 16 Required, Hole Diameter = .44	

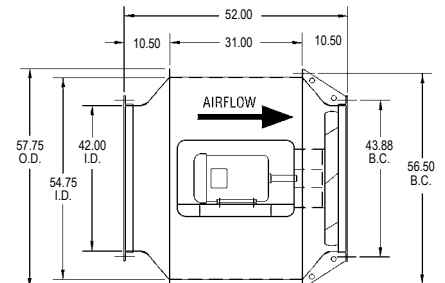

FAN RPM	MTR HP	PITCH	0" SP	1/8" SP	1/4" SP	3/8" SP	1/2" SP	5/8" SP	3/4" SP	7/8" SP	1" SP
			CFM	CFM	CFM	CFM	CFM	CFM	CFM	CFM	CFM
870	7 1/2	18	24000	23200	22300	21300	20000	18400	17000		
	10	23	26000	25000	24000	22850	21500	20000	18200		
	10	28	28000	27000	25800	24700	23200	23400	19200		
	15	33	29500	28400	27600	26400	25200	22800			
	15	37	31500	30400	29100	27800	26400	24000			

- Notes:**
- 1) Performance shown is for Installation Type D: ducted inlet, ducted outlet.
  - 2) Performance ratings do not include the effects of appurtenances in the airstream.
  - 3) Power rating (BHP) does not include drive losses.
  - 4) Approximate fan weights are less motor and accessories.

# Single Stage Fan Data

SSB - Bifurcator

## 048

Wheel Diameter = 48 in.	Maximum RPM = 870
Tip Speed, FPM = 12.57 x RPM	Unit Weight = 1094 lbs.
Outlet Flange Screws: 16 Required, Hole Diameter = .59	

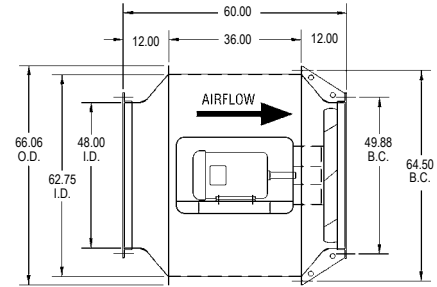

FAN RPM	MTR HP	PITCH	0" SP	1/8" SP	1/4" SP	3/8" SP	1/2" SP	5/8" SP	3/4" SP	7/8" SP	1" SP
			CFM	CFM	CFM	CFM	CFM	CFM	CFM	CFM	CFM
870	15	18	35800	34800	33750	32900	31500	30000	28750	27250	25000
	15	23	38600	37400	36250	35000	33900	32250	30500	28750	26500
	20	28	41300	40250	39100	37900	36600	35000	32500	30500	27500
	25	33	44000	43100	42000	40500	39250	38000	35250	32600	
	30	37	47000	46000	44750	43500	42250	40750	38100	34000	

## 060

Wheel Diameter = 60 in.	Maximum RPM = 870
Tip Speed, FPM = 15.71 x RPM	Unit Weight = 2366 lbs.
Outlet Flange Screws: 24 Required, Hole Diameter = .59	

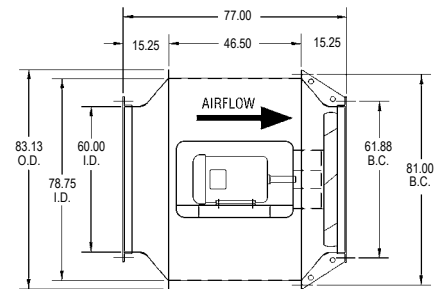

FAN RPM	MTR HP	PITCH	0" SP	1/8" SP	1/4" SP	3/8" SP	1/2" SP	5/8" SP	3/4" SP	7/8" SP	1" SP
			CFM	CFM	CFM	CFM	CFM	CFM	CFM	CFM	CFM
690	25	23	60000	58000	56250	54500	52500	49750	46750	44000	40500
	30	28	64000	62500	61000	59000	56500	53500	49500	46900	
	40	33	68000	66750	65000	62500	61000	58750	54500	49000	
870	50	23	73250	74250	72250	71000	69700	68000	67000	65000	62750
	60	28	80750	80000	78500	77000	75700	74000	72800	71000	68000
	75	33	86000	85000	83500	82000	80250	78000	77000	75750	74000

FAN RPM	MTR HP	PITCH	1 1/4" SP	1 1/2" SP
			CFM	CFM
870	50	23	58500	54000
	60	28	63000	57500
	75	33	66500	60000

- Notes:**
- 1) Performance shown is for Installation Type D: ducted inlet, ducted outlet.
  - 2) Performance ratings do not include the effects of appurtenances in the airstream.
  - 3) Power rating (BHP) does not include drive losses.
  - 4) Approximate fan weights are less motor and accessories.

# Two Stage Fan Data

Bifurcator - TSB

## 016

Wheel Diameter = 16 in.	Maximum RPM = 1750
Tip Speed, FPM = 4.19 x RPM	Unit Weight = 167 lbs.
Outlet Flange Screws: 8 Required, Hole Diameter = .38	

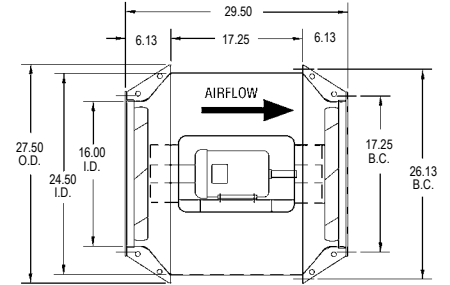

FAN RPM	MTR HP	PITCH	0" SP	1/4" SP	1/2" SP	3/4" SP	1" SP	1 1/4" SP	1 1/2" SP	1 3/4" SP	2" SP
			CFM	CFM	CFM	CFM	CFM	CFM	CFM	CFM	CFM
1750	1 1/2	27	1245	2690	2520	2340	2160	1950	1735	1460	1220

FAN RPM	MTR HP	PITCH	2 1/4" SP	2 1/2" SP
			CFM	CFM
1750	1 1/2	27	1045	880

## 018

Wheel Diameter = 18 in.	Maximum RPM = 1750
Tip Speed, FPM = 4.71 x RPM	Unit Weight = 235 lbs.
Outlet Flange Screws: 8 Required, Hole Diameter = .44	

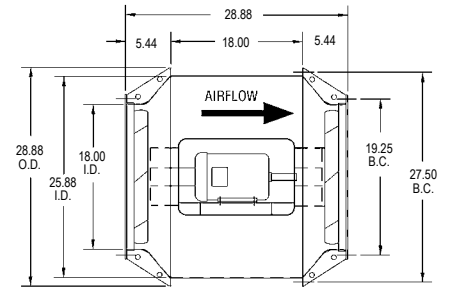

FAN RPM	MTR HP	PITCH	0" SP	1/4" SP	1/2" SP	3/4" SP	1" SP	1 1/4" SP	1 1/2" SP	1 3/4" SP	2" SP
			CFM	CFM	CFM	CFM	CFM	CFM	CFM	CFM	CFM
1750	3	18	4100	3875	3625	3425	3200	2900	2550		
	3	28	4800	4525	4300	4050	3800	3550	3250	2700	
	3	37	5550	5300	5050	4750	4500	4200	3800	3400	2500

## 021

Wheel Diameter = 21 in.	Maximum RPM = 1750
Tip Speed, FPM = 5.50 x RPM	Unit Weight = 258 lbs.
Outlet Flange Screws: 8 Required, Hole Diameter = .44	

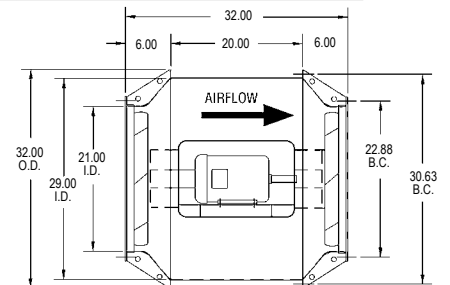

FAN RPM	MTR HP	PITCH	0" SP	1/4" SP	1/2" SP	3/4" SP	1" SP	1 1/4" SP	1 1/2" SP	1 3/4" SP	2" SP
			CFM	CFM	CFM	CFM	CFM	CFM	CFM	CFM	CFM
1750	3	18	6500	6250	5950	5700	5450	5200	4850	4500	4100
	5	28	7650	7400	7100	6800	6500	6200	5850	5450	5000
	5	33	8200	7950	7650	7400	7100	6800	6500	6125	5725

FAN RPM	MTR HP	PITCH	2 1/4" SP	2 1/2" SP
			CFM	CFM
1750	3	18	3500	
	5	28	4500	3500
	5	33	5200	4500

- Notes:**
- 1) Performance shown is for Installation Type D: ducted inlet, ducted outlet.
  - 2) Performance ratings do not include the effects of appurtenances in the airstream.
  - 3) Power rating (BHP) does not include drive losses.
  - 4) Approximate fan weights are less motor and accessories.
  - 5) Size 016 fans will always be furnished with a 4-blade prop. Larger sizes will be furnished with an 8-blade prop.

# Two Stage Fan Data

TSB - Bifurcator

## 024

Wheel Diameter = 24 in.	Maximum RPM = 1750
Tip Speed, FPM = 6.28 x RPM	Unit Weight = 413 lbs.
Outlet Flange Screws: 8 Required, Hole Diameter = .44	

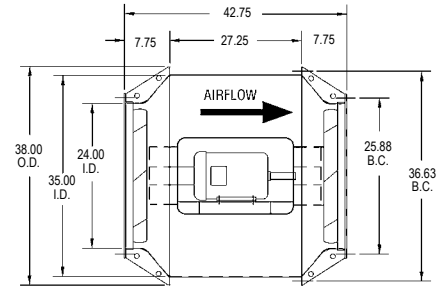

FAN RPM	MTR HP	PITCH	0" SP	1/4" SP	1/2" SP	3/4" SP	1" SP	1 1/4" SP	1 1/2" SP	1 3/4" SP	2" SP
			CFM	CFM	CFM	CFM	CFM	CFM	CFM	CFM	CFM
1160	5	37	9075	8550	8000	7400	6700	5900	4500		
	10	23	11100	10800	10400	10100	9700	9300	8850	8500	8100
1750	10	33	12700	12400	12000	11700	11300	10900	10550	10200	9700

FAN RPM	MTR HP	PITCH	2 1/4" SP	2 1/2" SP	2 3/4" SP	3" SP	3 1/4" SP	3 1/2" SP	3 3/4" SP	4" SP
			CFM	CFM	CFM	CFM	CFM	CFM	CFM	CFM
1750	10	23	7700	7200	6500	5600				
	10	33	9300	8700	8200	7400	6650			

## 027

Wheel Diameter = 27 in.	Maximum RPM = 1750
Tip Speed, FPM = 7.07 x RPM	Unit Weight = 638 lbs.
Outlet Flange Screws: 8 Required, Hole Diameter = .44	

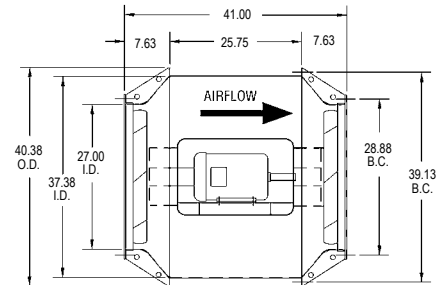

FAN RPM	MTR HP	PITCH	0" SP	1/4" SP	1/2" SP	3/4" SP	1" SP	1 1/4" SP	1 1/2" SP	1 3/4" SP	2" SP
			CFM	CFM	CFM	CFM	CFM	CFM	CFM	CFM	CFM
1750	10	18	14500	14200	13900	13500	13200	12700	12300	11900	11500
	15	28	16800	16500	16100	15700	15300	14800	14400	14000	13600

FAN RPM	MTR HP	PITCH	2 1/4" SP	2 1/2" SP	2 3/4" SP	3" SP	3 1/4" SP	3 1/2" SP	3 3/4" SP	4" SP
			CFM	CFM	CFM	CFM	CFM	CFM	CFM	CFM
1750	10	18	11100	10700	10300	9750	9000	7800	7000	
	15	28	13100	12600	12100	11500	11000	10200	9500	8400

- Notes:**
- 1) Performance shown is for Installation Type D: ducted inlet, ducted outlet.
  - 2) Performance ratings do not include the effects of appurtenances in the airstream.
  - 3) Power rating (BHP) does not include drive losses.
  - 4) Approximate fan weights are less motor and accessories.

# Two Stage Fan Data

Bifurcator - TSB

## 030

Wheel Diameter = 30 in.	Maximum RPM = 1160
Tip Speed, FPM = 7.85 x RPM	Unit Weight = 730 lbs.
Outlet Flange Screws: 16 Required, Hole Diameter = .44	

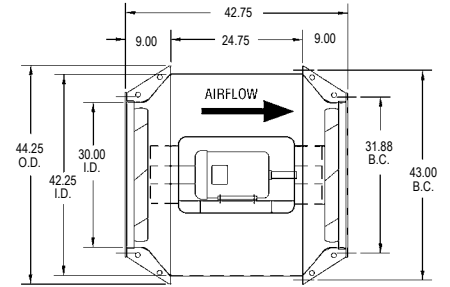

FAN RPM	MTR HP	PITCH	0" SP	1/4" SP	1/2" SP	3/4" SP	1" SP	1 1/4" SP	1 1/2" SP	1 3/4" SP	2" SP
			CFM	CFM	CFM	CFM	CFM	CFM	CFM	CFM	CFM
1160	7 1/2	18	13000	12500	12000	11400	10800	10100	9300	8400	
	7 1/2	23	14100	13500	12900	12250	11600	10800	10000	8900	
	7 1/2	28	15200	14600	14000	13450	12800	12175	11200	10000	7800
	10	33	16375	15900	15200	14600	14000	13400	12700	11500	9700
	10	37	17500	17000	16400	15750	15000	14300	13400	12400	11000

## 036

Wheel Diameter = 36 in.	Maximum RPM = 1160
Tip Speed, FPM = 9.42 x RPM	Unit Weight = 823 lbs.
Outlet Flange Screws: 16 Required, Hole Diameter = .44	

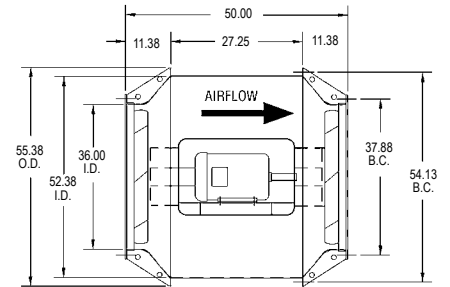

## +036

For use with 324T motor frame.

Wheel Diameter = 36 in.	Maximum RPM = 1160
Tip Speed, FPM = 9.42 x RPM	Unit Weight = 900 lbs.
Outlet Flange Screws: 16 Required, Hole Diameter = .44	

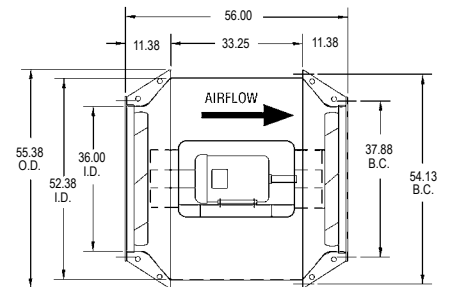

FAN RPM	MTR HP	PITCH	0" SP	1/4" SP	1/2" SP	3/4" SP	1" SP	1 1/4" SP	1 1/2" SP	1 3/4" SP	2" SP
			CFM	CFM	CFM	CFM	CFM	CFM	CFM	CFM	CFM
1160	15	18	22400	21800	21200	20500	19900	19200	18400	17600	16600
	20	23	24400	23600	23000	22300	21600	20800	20200	19600	18800
	20	28	26400	25700	25000	24100	23300	22600	21800	21200	20400
	25	33	28200	27600	27000	26200	25400	24700	24000	23200	22400
	25	37	30000	29400	28400	28100	27200	26400	25600	24800	24000

FAN RPM	MTR HP	PITCH	2 1/4" SP	2 1/2" SP	2 3/4" SP	3" SP
			CFM	CFM	CFM	CFM
1160	15	18	15600	14500	11300	
	20	23	17800	16500	14000	
	20	28	19400	18400	16500	
	25	33	21400	20000	18400	15200
	25	37	25200	22200	20500	17600

- Notes:**
- 1) Performance shown is for Installation Type D: ducted inlet, ducted outlet.
  - 2) Performance ratings do not include the effects of appurtenances in the airstream.
  - 3) Power rating (BHP) does not include drive losses.
  - 4) Approximate fan weights are less motor and accessories.

# Two Stage Fan Data

TSB - Bifurcator

## 042

Wheel Diameter = 42 in.	Maximum RPM = 1160
Tip Speed, FPM = 11.00 x RPM	Unit Weight = 1035 lbs.
Outlet Flange Screws: 16 Required, Hole Diameter = .44	

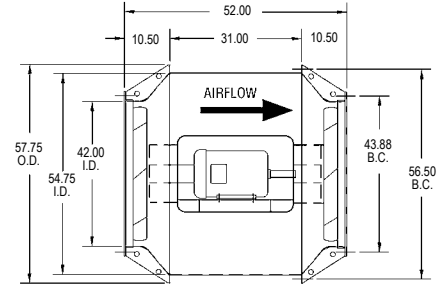

FAN RPM	MTR HP	PITCH	0" SP	1/4" SP	1/2" SP	3/4" SP	1" SP	1 1/4" SP	1 1/2" SP	1 3/4" SP	2" SP
			CFM	CFM	CFM	CFM	CFM	CFM	CFM	CFM	CFM
870	15	18	26800	25800	24800	23800	22800	21500	20000	18500	16800
	20	23	29200	28000	26800	25700	24700	23600	22400	20900	18600
	20	28	31400	30200	29100	28000	27000	25800	24500	23000	20800
	25	33	33600	32800	31600	30400	29200	28000	27000	25400	23000
	30	37	35800	34800	34000	32750	31400	30200	29000	27400	25400

FAN RPM	MTR HP	PITCH	2 1/4" SP	2 1/2" SP
			CFM	CFM
870	25	33	19000	
	30	37	22000	

## 048

Wheel Diameter = 48 in.	Maximum RPM = 870
Tip Speed, FPM = 12.57 x RPM	Unit Weight = 1258 lbs.
Outlet Flange Screws: 16 Required, Hole Diameter = .59	

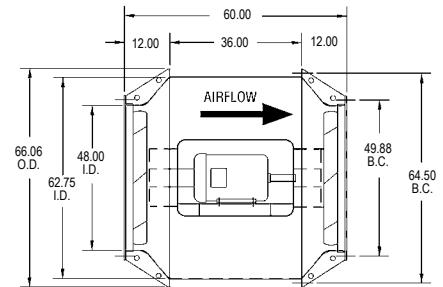

FAN RPM	MTR HP	PITCH	0" SP	1/4" SP	1/2" SP	3/4" SP	1" SP	1 1/4" SP	1 1/2" SP	1 3/4" SP	2" SP
			CFM	CFM	CFM	CFM	CFM	CFM	CFM	CFM	CFM
870	25	18	40200	39200	38000	37000	35600	34200	33000	31600	30000
	30	23	43800	42800	42000	41000	39600	38200	36800	35400	33400
	40	28	47000	46000	44800	43800	42200	40800	39600	38400	36800
	40	33	50400	49600	48400	47000	45400	44000	42800	41400	40200
	50	37	54000	52800	51400	50400	48800	47000	45600	44600	43000

FAN RPM	MTR HP	PITCH	2 1/4" SP	2 1/2" SP	2 3/4" SP	3" SP
			CFM	CFM	CFM	CFM
870	25	18	28000	26000	21600	
	30	23	31200	28800	25600	
	40	28	34600	32400	29000	
	40	33	38400	36000	33000	27000
	50	37	41000	39000	36200	32000

- Notes:**
- 1) Performance shown is for Installation Type D: ducted inlet, ducted outlet.
  - 2) Performance ratings do not include the effects of appurtenances in the airstream.
  - 3) Power rating (BHP) does not include drive losses.
  - 4) Approximate fan weights are less motor and accessories.

# Sample Specifications

## Axial Bifurcator Fan - SSB/TSB

- 1.1 Fans shall be tested and rated in accordance with AMCA air and sound methods and standards.
- 1.2 All motors and electrical components shall comply with NEMA, UL or other governing group.

### Single Stage

#### PRODUCT

- 2.1 Fan shall be of axial type configuration.
- 2.2 Fan shall be direct drive as shown on schedule.
- 2.3 Fan housing shall be of all welded construction with a flanged inlet and outlet, and shall be constructed completely of carbon steel, stainless steel (type 316 or 304) or aluminum as specified on fan schedule.
  - 2.3.1 The fan housing shall have an integrally designed removable section to allow for impeller inspection or removal while the fan assembly remains installed.
- 2.4 Motor shall be separated from the air stream and is located in an easily accessible and visible chamber. This chamber bifurcates the fan housing and the air stream.
- 2.5 When required, the fan shall be equipped to be capable of continuous operation at 250°F, 450°F, 750°F or 1000°F, as indicated on the fan schedule.
  - 2.5.1 The fan shall perform at the elevated temperatures without any additional external cooling fans other than its own integral mounted cooling wheels.
- 2.6 Propeller shall be of axial flow type consisting of riveted construction that shall be of carbon steel or stainless steel, as indicated on the fan schedule.
- 2.7 The electric motor shall be as specified on fan schedule and is available in any enclosure as made available from the motor vendors. The motor shall be of a typical NEMA -T frame type and standard in nature with the motor industry and is readily available, unless specified otherwise due to application warranting such.
- 2.8 Fan shall be of AMCA spark resistant construction when required and as indicated on the fan schedule as either AMCA "A", "B" or "C".
- 2.9 Fan shall be coated with enamel as standard or any other available coating as made available by coating suppliers and as indicated on the fan schedule.
- 2.10 The final complete fan assembly is vibration tested and balanced as per AMCA 204 Grade BV-3 / ANSI S2.19 G 6.3.

#### ACCESSORIES

- 3.1 Fan manufacturer shall supply a NEMA rated disconnect when required as shown on the fan schedule.
- 3.2 The motor chamber shall have either louvered or birdscreen covers as shown on the fan schedule.
- 3.3 The fan manufacturer shall supply motor "Slide-out" option, which provides for easy motor access via the bifurcator chamber end, as specified in the fan schedule.

### Two Stage

#### PRODUCT

- 2.1 Fan shall be of axial type configuration.
- 2.2 Fan shall be direct drive as shown on schedule.
- 2.3 Fan housing shall be of all welded construction with a flanged inlet and outlet, and shall be constructed completely of carbon steel, stainless steel (type 316 or 304) or aluminum as specified on fan schedule.
  - 2.3.1 The fan housing shall have two integrally designed removable cone sections to allow for impeller inspection or removal while the fan assembly remains installed.
- 2.4 Double-shafted motor shall be separated from the air stream and is located in an easily accessible and visible chamber. This chamber bifurcates the fan housing and the air stream.
- 2.5 When required, the fan shall be equipped to be capable of continuous operation at 250°F, 450°F, 750°F or 1000°F, as indicated on the fan schedule.
  - 2.5.1 The fan shall perform at the elevated temperatures without any additional external cooling fans other than its own integral mounted cooling wheels.
- 2.6 Both propellers shall be of the axial flow type consisting of riveted construction that shall be of carbon steel or stainless steel, as indicated on the fan schedule.
- 2.7 The double-shafted electric motor shall be as specified on fan schedule and is available in any enclosure as made available from the motor vendors. The motor shall be of a typical NEMA -T frame type and standard in nature with the motor industry and is readily available, unless specified otherwise due to application warranting such.
- 2.8 Fan shall be of AMCA spark resistant construction when required and as indicated on the fan schedule as either AMCA "A", "B" or "C".
- 2.9 Fan shall be coated with enamel as standard or any other available coating as made available by coating suppliers and as indicated on the fan schedule.
- 2.10 The final complete fan assembly is vibration tested and balanced as per AMCA 204 Grade BV-3 / ANSI S2.19 G 6.3.

#### ACCESSORIES

- 3.1 Fan manufacturer shall supply a NEMA rated disconnect when required as shown on the fan schedule.
- 3.2 The motor chamber shall have either louvered or birdscreen covers as shown on the fan schedule.
- 3.3 The fan manufacturer shall supply motor "Slide-out" option, which provides for easy motor access via the bifurcator chamber end, as specified in the fan schedule.



# One Year Limited Warranty

Axial Bifurcator Fan - SSB/TSB

---

## What Products Are Covered

PennBarry Commercial and Industrial Fans (each, a "PennBarry Product")

## One Year Limited Warranty For PennBarry Products

PennBarry warrants to the original commercial purchaser that the PennBarry Products will be free from defects in material and workmanship for a period of one (1) year from the date of shipment.

## Exclusive Remedy

PennBarry will, at its option, repair or replace (without removal or installation) the affected components of any defective PennBarry Product; repair or replace (without removal or installation) the entire defective PennBarry Product; or refund the invoiced price of the PennBarry Product. In all cases, a reasonable time period must be allowed for warranty repairs to be completed.

## What You Must Do

In order to make a claim under these warranties:

1. You must be the original commercial purchaser of the PennBarry Product.
2. You must promptly notify us within the warranty period of any defect and provide us with any substantiation that we may reasonably request.
3. The PennBarry Product must have been installed and maintained in accordance with good industry practice and any specific PennBarry recommendations.

## Exclusions

These warranties do not cover defects caused by:

1. Improper design or operation of the system into which the PennBarry Product is incorporated.
2. Improper installation.
3. Accident, abuse or misuse.
4. Unreasonable use (including any use for non-commercial purposes, failure to provide reasonable and necessary maintenance as specified by PennBarry, misapplication and operation in excess of stated performance characteristics).
5. Components not manufactured by PennBarry.

## Limitations

1. In all cases, PennBarry reserves the right to fully satisfy its obligations under the Limited Warranties by refunding the invoiced price of the defective PennBarry Product (or, if the PennBarry Product has been discontinued, of the most nearly comparable current product).
2. PennBarry reserves the right to furnish a substitute or replacement component or product in the event a PennBarry Product or any component of the product is discontinued or otherwise unavailable.
3. PennBarry's only obligation with respect to components not manufactured by PennBarry shall be to pass through the warranty made by the manufacturer of the defective component.

## General

**The foregoing warranties are exclusive and in lieu of all other warranties except that of title, whether written, oral or implied, in fact or in law (including any warranty of merchantability or fitness for a particular purpose).**

**PennBarry hereby disclaims any liability for special, punitive, indirect, incidental or consequential damages, including without limitation lost profits or revenues, loss of use of equipment, cost of capital, cost of substitute products, facilities or services, downtime, shutdown or slowdown costs.**

The remedies of the original commercial purchaser set forth herein are exclusive and the liability of PennBarry with respect to the PennBarry Products, whether in contract, tort, warranty, strict liability or other legal theory shall not exceed the invoiced price charged by PennBarry to its customer for the affected PennBarry Product at the time the claim is made.

Inquiries regarding these warranties should be sent to: PennBarry, 1401 North Plano Road, Richardson, TX 75081.

# OTHER PENNBARRY PRODUCTS

## CENTRIFUGAL PRODUCTS



**Domex**  
Centrifugal  
Roof Exhausters



**Fumex Fatrap**  
Kitchen Hood Centrifugal  
Roof Exhausters



**Zephyr**  
Ceiling and Inline Fans



**Dynamo**  
Centrifugal Blowers



**Centrex Inliner**  
Centrifugal Inline Fans



**LC Dynafan**  
Low Contour Centrifugal  
Roof Exhausters



**ESI**  
Efficient Silent  
Inline Fan



**Fume Exhaust**  
Curb Mounted  
Centrifugal Fans

## AXIAL / GRAVITY PRODUCTS

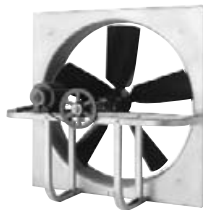

**Breezeway**  
Propeller Wall Fans



**HI-EX**  
Power Roof Ventilator



**Tubeaxial**  
Inline Fans



**Vaneaxial**  
Inline Fans



**Powered Airette**  
Axial Roof Ventilators



**Airette**  
Gravity Intake/Relief Hood



**Domex Axial**  
Axial Roof Ventilators



**Axcentrix**  
Bifurcator Fan

For more information contact your local PennBarry Sales  
Manufacturer Representative or visit us at [www.PennBarry.com](http://www.PennBarry.com)

